

Report of Test

LLIA001168-005A-R01*

Indoor Distribution Photometry Test Report

Catalog Number: MLR5RG-MO-K35-80-4-XX-LOH-UNV

Recessed ceiling mounted, extruded aluminum housing, formed white enamel aluminum reflector, translucent white plastic enclosure.

144 white LEDs, four Osram PrevaLED BARs with 36 LEDs each.

One Osram Optotronic OTi 20/120-277/700 DIM-1 L G2 LED driver labeled as 440mA.

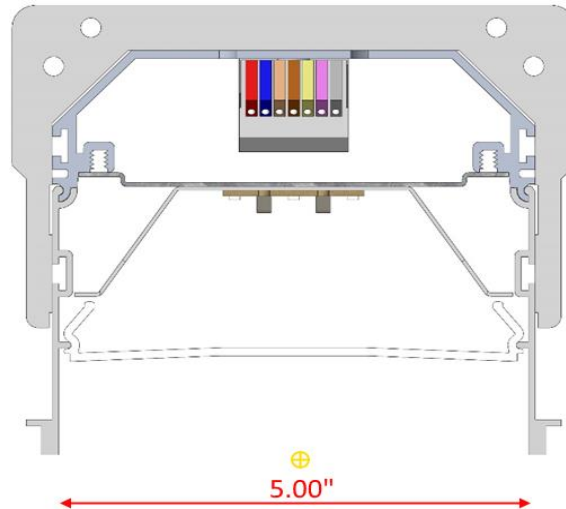

Prepared For:
Precision Architectural Lighting
4830 Timber Creek Drive
Houston, TX 77017, USA

Performance Summary			
Input Voltage	120.0 V	Luminous Flux	2074.2 Lumens
Input Current	0.1444 A	Total Efficacy	120.8 Lm/W
Input Power	17.17 W	Downward Flux	2074.1 Lumens
Frequency	60.00 Hz	Downward Flux	100.0 % of Total
Power Factor	0.990		
Current THD	6.3 %		

*This test report supersedes test report LLIA001168-005A

This test report was issued by LightLab International Allentown, LLC without alterations or erasures.

Test date: 11/01/2019

Report date: 08/20/2020

Signed: _____

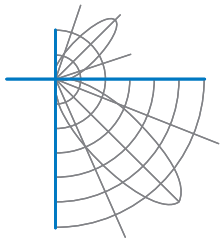

Report of Test

LLIA001168-005A-R01

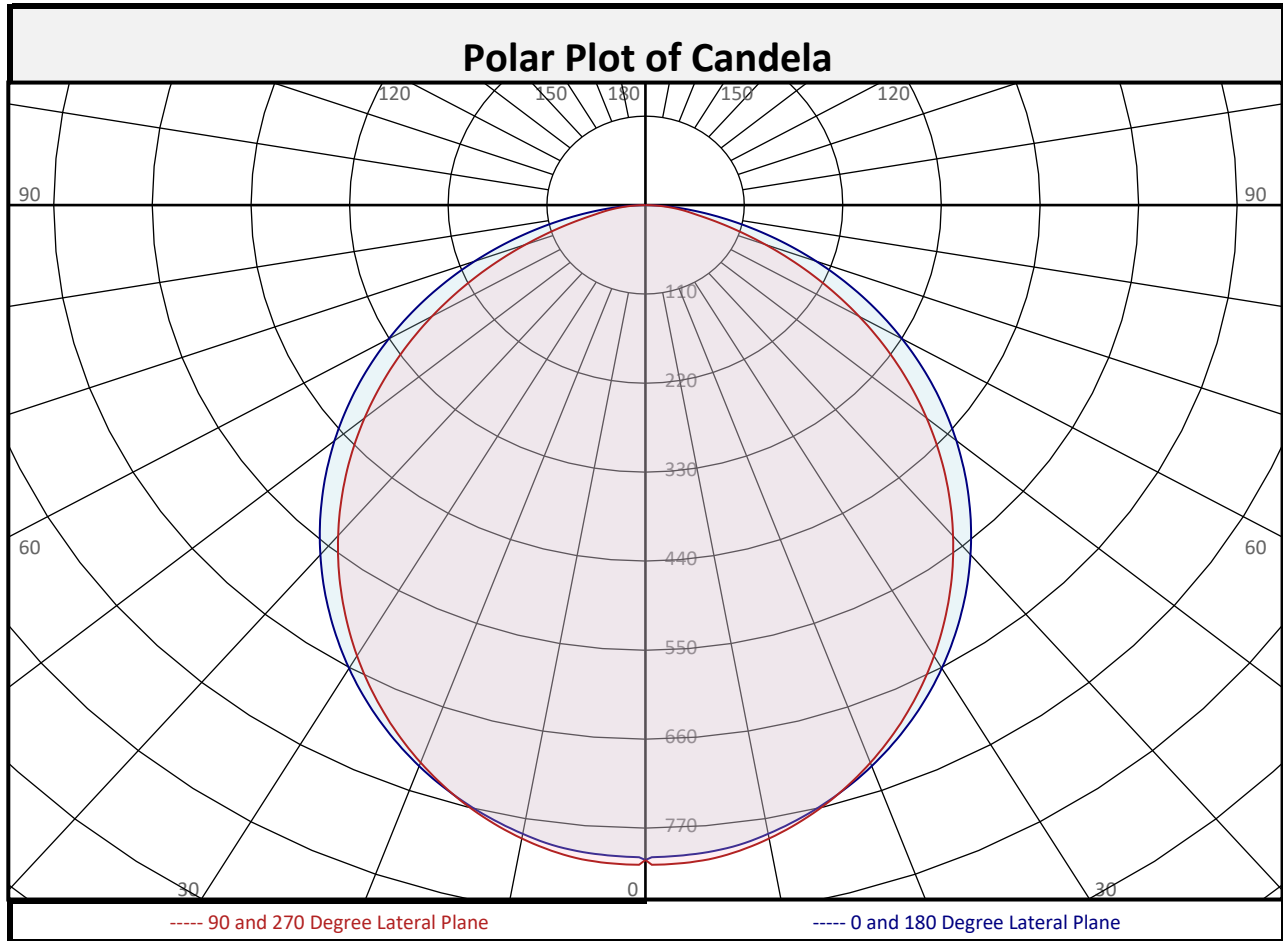

Zonal Flux Summary

Zone (Deg Vert)	Flux (Lumens)	Percent of Total	Zone (Deg Vert)	Flux (Lumens)	Percent of Total	Zone (Deg Vert)	Flux (Lumens)	Percent of Total
0-10	76.5	3.7%	90-100	0.0	0.0%	0-20	292.9	14.1%
10-20	216.4	10.4%	100-110	0.0	0.0%	0-30	613.4	29.6%
20-30	320.5	15.5%	110-120	0.0	0.0%	0-40	989.2	47.7%
30-40	375.7	18.1%	120-130	0.0	0.0%	0-60	1693	81.6%
40-50	377.2	18.2%	130-140	0.0	0.0%	0-80	2045	98.6%
50-60	327.0	15.8%	140-150	0.0	0.0%	10-90	1998	96.3%
60-70	233.3	11.2%	150-160	0.0	0.0%	20-50	1073	51.7%
70-80	118.1	5.7%	160-170	0.0	0.0%	40-90	1085	52.3%
80-90	29.4	1.4%	170-180	0.0	0.0%	60-90	380.8	18.4%
0-90	2074	100.0%	90-180	0.0	0.0%	0-180	2074	100.0%

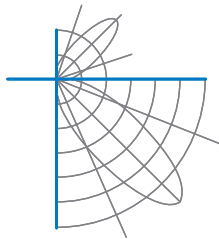

Report of Test

LLIA001168-005A-R01

Luminous Intensity (Candela) Table

		Lateral (C-Plane) Angles								
		0	22.5	45	67.5	90	112.5	135	157.5	180
Vertical (Gamma) Angles	0	809	809	809	809	809	809	809	809	809
	2.5	805	806	807	811	815	811	807	806	805
	5	803	803	805	808	812	808	805	803	803
	7.5	798	799	800	802	805	802	800	799	798
	10	789	791	792	793	795	793	792	791	789
	12.5	779	780	781	782	783	782	781	780	779
	15	767	768	767	768	768	768	767	768	767
	17.5	753	754	751	752	752	752	751	754	753
	20	738	738	734	734	733	734	734	738	738
	22.5	721	720	715	714	713	714	715	720	721
	25	702	701	694	692	691	692	694	701	702
	27.5	682	680	672	669	668	669	672	680	682
	30	661	658	649	645	644	645	649	658	661
	32.5	638	635	624	619	618	619	624	635	638
	35	614	610	599	593	591	593	599	610	614
	37.5	590	584	572	565	563	565	572	584	590
	40	564	558	544	536	534	536	544	558	564
	42.5	537	530	516	507	504	507	516	530	537
	45	510	502	487	477	473	477	487	502	510
	47.5	482	473	457	446	441	446	457	473	482
50	453	443	427	414	409	414	427	443	453	
52.5	423	413	396	382	376	382	396	413	423	
55	392	383	365	349	343	349	365	383	392	
57.5	362	351	333	316	309	316	333	351	362	
60	331	320	300	283	275	283	300	320	331	
62.5	299	288	268	249	241	249	268	288	299	
65	267	257	235	215	207	215	235	257	267	
67.5	234	225	202	181	174	181	202	225	234	
70	202	193	170	149	142	149	170	193	202	
72.5	171	162	137	118	112	118	137	162	171	
75	140	131	107	90	86	90	107	131	140	
77.5	110	102	78	66	63	66	78	102	110	
80	82	74	54	49	49	49	54	74	82	
82.5	57	47	37	36	36	36	37	47	57	
85	34	26	24	23	23	23	24	26	34	
87.5	14	11	11	11	11	11	11	11	14	
90	0	0	1	1	1	1	1	0	0	

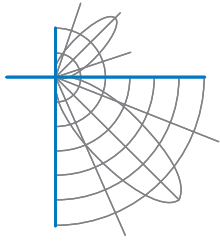

Report of Test

LLIA001168-005A-R01

Luminous Intensity (Candela) Table

		Lateral (C-Plane) Angles								
		0	22.5	45	67.5	90	112.5	135	157.5	180
Vertical (Gamma) Angles	90	0	0	1	1	1	1	1	0	0
	92.5	0	0	0	0	0	0	0	0	0
	95	0	0	0	0	0	0	0	0	0
	97.5	0	0	0	0	0	0	0	0	0
	100	0	0	0	0	0	0	0	0	0
	102.5	0	0	0	0	0	0	0	0	0
	105	0	0	0	0	0	0	0	0	0
	107.5	0	0	0	0	0	0	0	0	0
	110	0	0	0	0	0	0	0	0	0
	112.5	0	0	0	0	0	0	0	0	0
	115	0	0	0	0	0	0	0	0	0
	117.5	0	0	0	0	0	0	0	0	0
	120	0	0	0	0	0	0	0	0	0
	122.5	0	0	0	0	0	0	0	0	0
	125	0	0	0	0	0	0	0	0	0
	127.5	0	0	0	0	0	0	0	0	0
	130	0	0	0	0	0	0	0	0	0
	132.5	0	0	0	0	0	0	0	0	0
	135	0	0	0	0	0	0	0	0	0
	137.5	0	0	0	0	0	0	0	0	0
	140	0	0	0	0	0	0	0	0	0
	142.5	0	0	0	0	0	0	0	0	0
	145	0	0	0	0	0	0	0	0	0
	147.5	0	0	0	0	0	0	0	0	0
150	0	0	0	0	0	0	0	0	0	
152.5	0	0	0	0	0	0	0	0	0	
155	0	0	0	0	0	0	0	0	0	
157.5	0	0	0	0	0	0	0	0	0	
160	0	0	0	0	0	0	0	0	0	
162.5	0	0	0	0	0	0	0	0	0	
165	0	0	0	0	0	0	0	0	0	
167.5	0	0	0	0	0	0	0	0	0	
170	0	0	0	0	0	0	0	0	0	
172.5	0	0	0	0	0	0	0	0	0	
175	0	0	0	0	0	0	0	0	0	
177.5	0	0	0	0	0	0	0	0	0	
180	0	0	0	0	0	0	0	0	0	

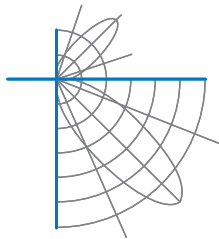

Report of Test

LLIA001168-005A-R01

Coefficients of Utilization/Room Utilization - Zonal Cavity Method																						
Effective Floor Cavity Reflectance 0.20																						
RC	80					70					50				30				10			0
RW	70	50	30	10		70	50	30	10		50	30	10		50	30	10		50	30	10	0
RCR																						
0	119	119	119	119		116	116	116	116		111	111	111		106	106	106		102	102	102	100
1	109	105	101	97		107	102	99	95		98	95	92		94	92	90		91	89	87	85
2	100	92	85	80		97	90	84	79		86	81	77		83	79	75		80	77	73	71
3	91	81	73	67		89	79	72	66		76	70	65		74	68	64		71	67	63	61
4	84	72	63	57		81	71	63	56		68	61	56		66	60	55		64	58	54	52
5	77	64	56	49		75	63	55	49		61	54	48		59	53	48		57	52	47	45
6	71	58	49	43		69	57	49	43		55	48	42		54	47	42		52	46	42	40
7	66	53	44	38		64	52	44	38		50	43	38		49	42	37		48	42	37	35
8	62	48	40	34		60	48	40	34		46	39	34		45	38	34		44	38	33	31
9	58	44	36	31		56	44	36	31		43	35	30		42	35	30		40	35	30	28
10	54	41	33	28		53	40	33	28		39	33	28		39	32	28		38	32	27	26

For absolute test reports, RUs are expressed as a percentage of total lumen output. For relative test reports, CUs are expressed as a percentage of total lamp output. Calculations were based on published IES procedures, and are based on the zonal cavity method. Basic assumptions: 1) Room surfaces are lambertian reflectors. 2) Incident flux on each surface is uniformly distributed. 3) The room is spectrally neutral. When luminaires are not evenly distributed throughout the room, or do not exhibit lateral symmetry, CU values may differ from actual performance.

Circle of Light Plot				
Height(ft)	Illuminance at Nadir (fc)	Ground-level distance to half-of-nadir illuminance (ft)		
		0-180 deg	90-270 deg	
6.0	22.5	7.30	7.13	
8.0	12.6	9.74	9.50	
10.0	8.1	12.17	11.88	
12.0	5.6	14.61	14.25	
14.0	4.1	17.04	16.63	
16.0	3.2	19.47	19.00	

Average Luminance (cd/m ²)			
	0 deg Plane	45 deg Plane	90 deg Plane
0	5339	5339	5339
45	4755	4542	4413
55	4513	4193	3944
65	4163	3668	3233
75	3557	2719	2185
85	2569	1797	1765

Spacing Criterion	
0 degree plane:	1.2
90 degree plane:	1.2
180 degree plane:	1.2
270 degree plane:	1.2

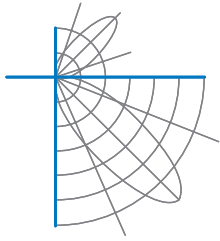

Report of Test
LLIA001168-005A-R01

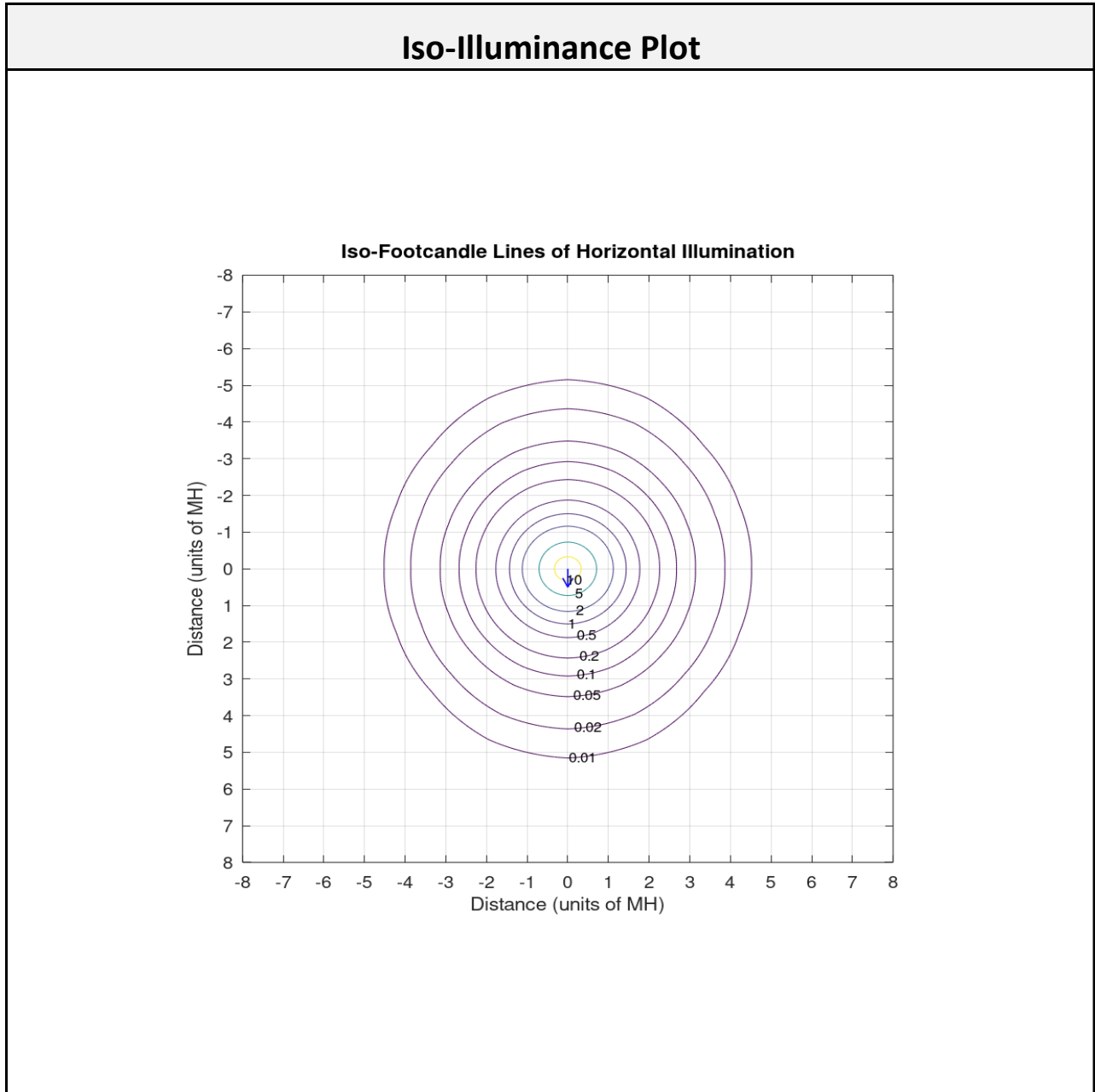

The isofootcandle values shown in the plot above are based on a mounting height of $h = 8.0$ feet. Grid values show multiples of mounting height. The isoilluminance contour lines are expressed in units of footcandles. The values expressed are based on the direct light from a single unit without the contribution of room reflections.

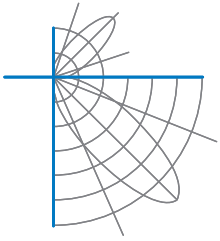

Report of Test
LLIA001168-005A-R01

Additional Pictures of Test Subject



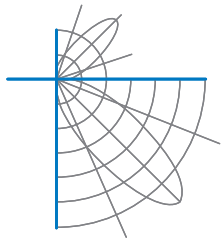

Report of Test

LLIA001168-005A-R01

Test Distance 9.5 m
Ambient Temperature 24.6 °C

Notes

The laboratory has not participated in the selection of samples to be tested. All testing is performed on the understanding that the significance of the report is limited to the extent that the test sample is representative of production units.

Tested in accordance with the applicable sections of publications: IES LM-79-19 and ANSI C82.77-10:2014. Format of reports and angular increments based on IES LM-41-14 and LM-46-04.

The luminous intensity values, and other derived quantities, contained in this report are based on the absolute data, as measured.

Prorating the performance of the sample for the use of other component combinations (such as lamp / LED / Ballast / driver), or for use in different environmental conditions than that tested, may produce erroneous results.

This report is free of erasures and corrections.

Photometric intensity values are reported using the CIE C-Gamma coordinate system as defined in CIE publication number 121.

This report may contain data that are not covered by the NVLAP accreditation. Quantities marked with ‡ are not covered.

This report must not be used by the customer to claim product certification, approval or endorsement by NVLAP, NIST, or any agency of the Federal Government.

Revision: R01 - 08/20/2020 Changed revision number to keep synchronized with 005B



Report of Test

LLIA001168-005B-R01*

Integrating Sphere Report

Catalog Number: MLR5RG-MO-K35-80-4-XX-LOH-UNV

Recessed ceiling mounted, extruded aluminum housing, formed white enamel aluminum reflector, translucent white plastic enclosure.

144 white LEDs, four Osram PrevaLED BARs with 36 LEDs each.

One Osram Optotronic OTi 20/120-277/700 DIM-1 L G2 LED driver labeled as 440mA.

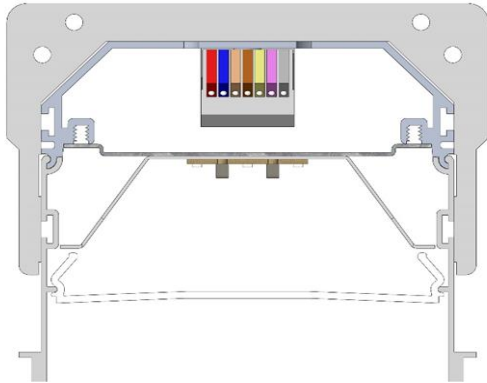

Performance Summary

Voltage	120.0 Vac
Current	0.1447 A
Power	17.17 W
Frequency	59.97 Hz
Power Factor	0.990
Current THD	6.1 %
Total Luminous Flux	2104.3 lm
Efficacy	122.6 lm/W
Chromaticity (x,y)	(0.4070, 0.3923)
(u',v')	(0.2362, 0.5122)
Duv	0.0003
CCT	3475 K
CRI (Ra)	82
R9	7
TM-30: Rf	81
TM-30: Rg	98

Prepared For:

Precision Architectural Lighting
4830 Timber Creek Drive
Houston, TX 77017, USA

*This test report supersedes test report LLIA001168-005B

Test date: 11/01/2019

Report date: 08/20/2020

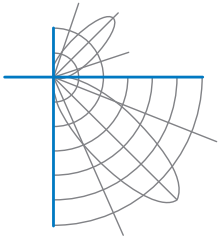

Test Report Number: LLIA001168-005B-R01

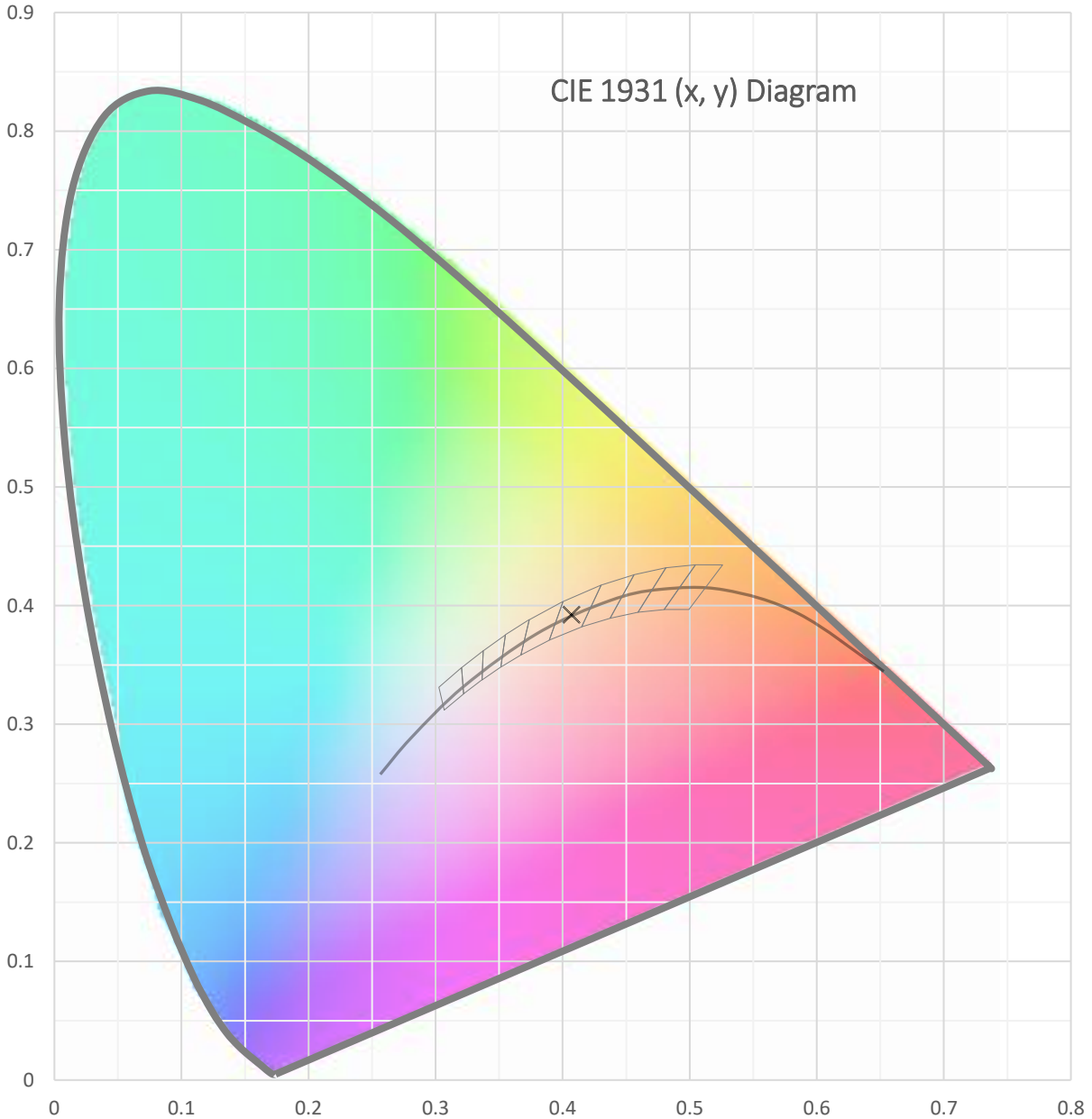

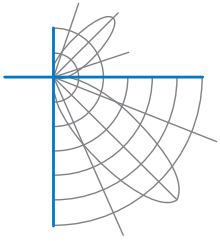

Test Report Number: LLIA001168-005B-R01

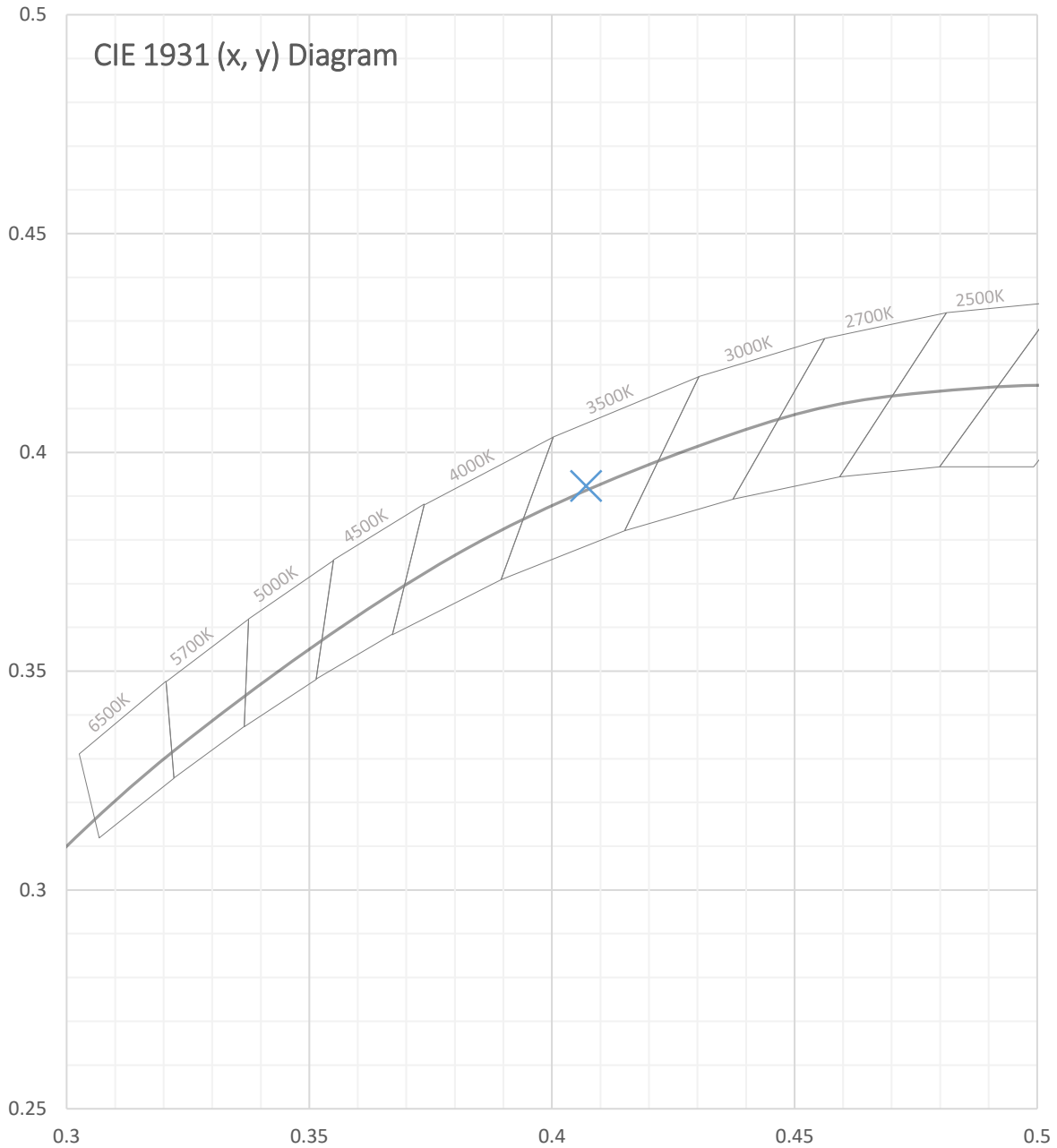

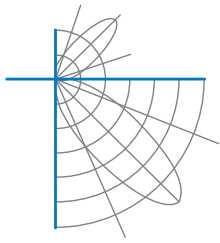

Test Report Number: LLIA001168-005B-R01

Total Radiant Flux	6.297 W
Total Luminous Flux	2104.3 Lm
Chromaticity CIE 1931 (x, y)	(0.4070, 0.3923)
Chromaticity CIE 1976 (u', v')	(0.2362, 0.5122)
Correlated Color Temperature (CCT)	3475 K
Color Rendering Index (Ra)	82
R1	82
R2	87
R3	93
R4	84
R5	81
R6	84
R7	85
R8	63
R9	7
R10	71
R11	84
R12	61
R13	83
R14	96
TM-30: Rf	81
TM-30: Rg	98
Distance from Planckian Locus (Duv)	0.0003
Scotopic/Photopic Ratio ‡	1.475

Electrical Data

Voltage	120.0 Vac
Current	0.1447 A
Power	17.17 W
Frequency	59.97 Hz
Power Factor	0.990
Current THD	6.1 %

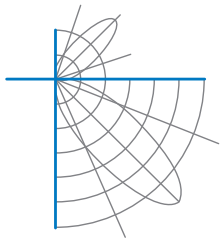

Test Report Number: LLIA001168-005B-R01

Summary Spectral Power Distribution (wavelength - nm, spectral power - mW/nm)

380	0.000256	480	0.004969	580	0.035399	680	0.009272
385	0.000278	485	0.005578	585	0.036999	685	0.007978
390	0.000374	490	0.007172	590	0.038390	690	0.006810
395	0.000483	495	0.010089	595	0.039238	695	0.005816
400	0.000625	500	0.013862	600	0.039633	700	0.004977
405	0.000754	505	0.017513	605	0.039429	705	0.004214
410	0.000899	510	0.020630	610	0.038571	710	0.003573
415	0.001123	515	0.022919	615	0.037266	715	0.003044
420	0.001624	520	0.024485	620	0.035395	720	0.002589
425	0.002681	525	0.025321	625	0.033362	725	0.002188
430	0.004935	530	0.026015	630	0.031008	730	0.001860
435	0.008980	535	0.026416	635	0.028637	735	0.001570
440	0.016127	540	0.026802	640	0.026045	740	0.001334
445	0.029312	545	0.027264	645	0.023545	745	0.001139
450	0.038058	550	0.027846	650	0.021047	750	0.000973
455	0.026917	555	0.028601	655	0.018647	755	0.000836
460	0.015956	560	0.029548	660	0.016471	760	0.000715
465	0.011505	565	0.030783	665	0.014339	765	0.000613
470	0.007706	570	0.032189	670	0.012453	770	0.000523
475	0.005311	575	0.033767	675	0.010767	775	0.000452
						780	0.000388

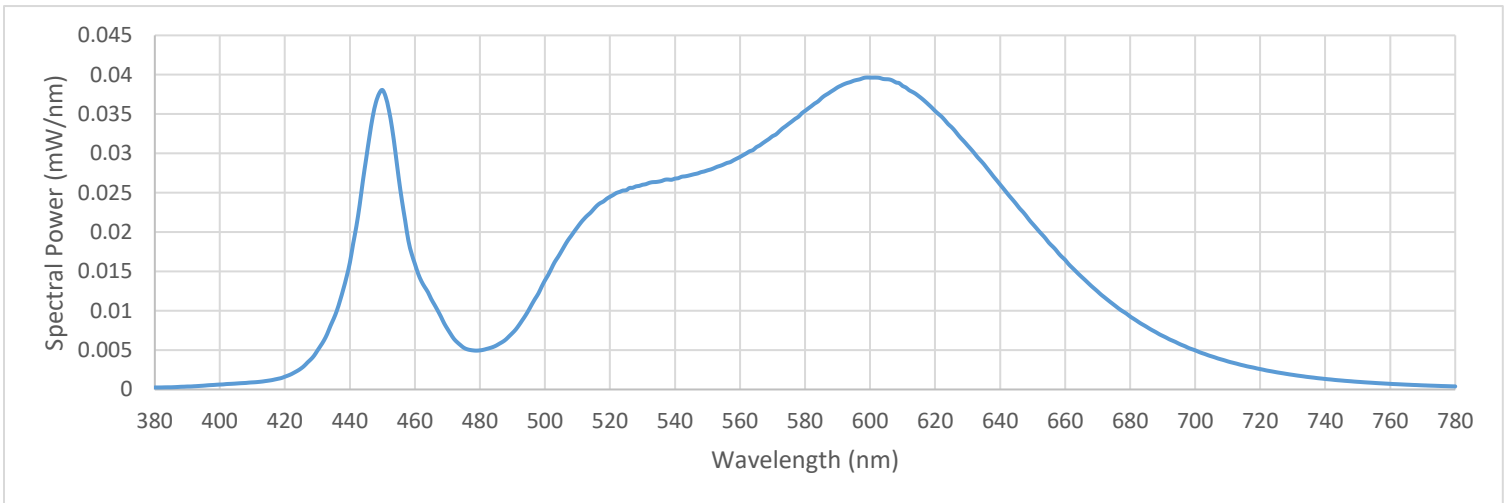

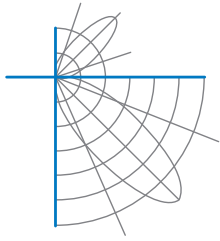

Test Report Number: LLIA001168-005B-R01

IES TM-30 Details

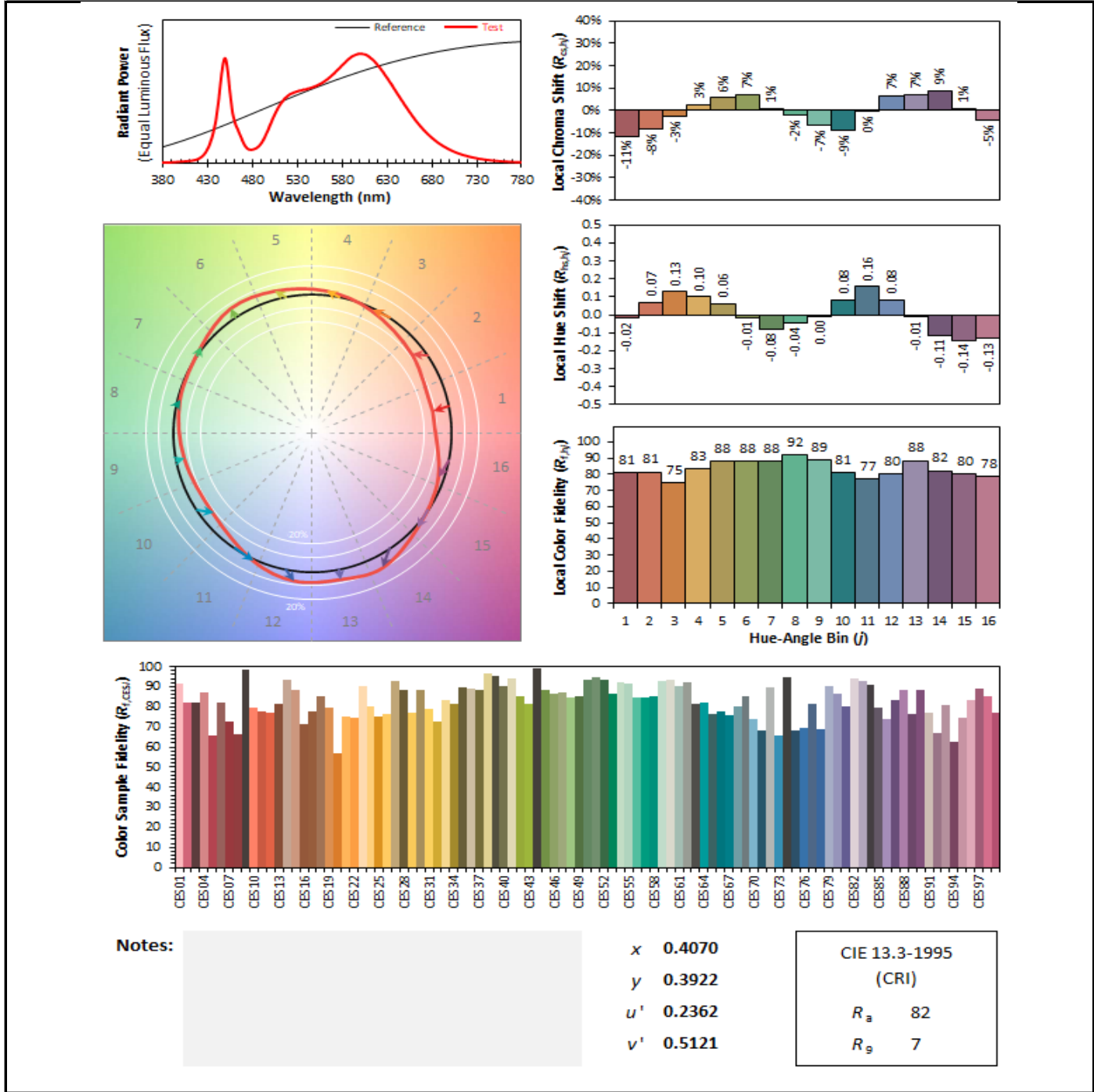

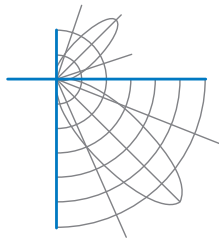

Test Report Number: LLIA001168-005B-R01

Test Equipment Configuration: LightLab International Allentown 2m Integrating Sphere
Measurements acquired using a Labsphere CDS 2600 spectroradiometer
Testing was performed using 4π geometry

Test Temperature: 25.5 °C

Test Procedure: Tested in accordance with the applicable sections of:
LM-79-19, LM-78-07, LM-58-13, ANSI_ANSI C78.377-2017, TM-30-18

Significance: The laboratory has not participated in the selection of samples to be tested.
All testing is performed on the understanding that the significance of the report is limited to the extent that the test sample is representative of production units.

Notes: The measurements and other derived quantities contained in this report are based on the absolute data as measured.

Prorating the performance of the sample for the use of other component combinations (such as lamp / LED / Ballast / driver), or for use in different environmental conditions than that tested, may produce erroneous results.

This report is free of erasures and corrections

This report may contain data that are not covered by the NVLAP accreditation. Quantities marked with ‡ are not covered.

This report must not be used by the customer to claim product certification, approval or endorsement by NVLAP, NIST, or any agency of the Federal Government.

Revision: R01 - 08/20/2020 Revised TM-30 test page to include additional summary metrics.